

# **Ray101E**

## **Handheld VHF**

## **Marine Radio**

### Owner's Handbook

Document number: 81230-3

Date: January 2005



# Contents

<b>About this Handbook .....</b>	<b>7</b>
<b>Important Information .....</b>	<b>8</b>
<b>Chapter 1: General Information .....</b>	<b>11</b>
1.1 Introduction .....	11
1.2 Features .....	11
1.3 Licensing Requirements .....	12
<b>Chapter 2: Installation .....</b>	<b>13</b>
2.1 Unpacking and Inspection .....	13
Equipment Supplied .....	13
2.2 Attaching the Antenna .....	13
2.3 Using the Belt Clip .....	14
2.4 Attaching the Wrist Strap .....	14
2.5 Battery Usage .....	14
Battery Tray .....	15
Charging Rechargeable Ni-MH Cells .....	17
Charger LED .....	18
Storage .....	19
<b>Chapter 3: Getting Started .....</b>	<b>21</b>
3.1 Keypad and Rotary Knobs .....	21
Rotary Keys .....	22
Push Keys .....	22
Description .....	22
1. PWR/VOL .....	22
2. SQ .....	22
3. PTT .....	22
4. UP/DOWN .....	23
5. Backlight / Keylock .....	23
6. 16/PLUS .....	23
7. DW/TRI .....	23
8. Frequency Band (*) .....	23
9. SCAN / SAVE .....	23
10. HI/LO / USER .....	23
3.2 LCD Display .....	24
1. (TX) Transmitting .....	24
2. (RX) Receiving .....	24
3. (USER) Favourite Channel Mode .....	24
4. (SAVED) Memory Mode .....	25
5. (P) Priority Mode .....	25
6. (SCAN) All Scan/Saved Scan/Priority Scan .....	25

7. (U I C) Channel Set .....	25
8. (B) Receive-only Channel .....	25
9. (A) Simplex Channel .....	25
10. Channel Number .....	25
11. Battery Level .....	25
12. Keylock .....	26
13. Indicators .....	26
14. Signal Strength .....	26
<b>Chapter 4: Operating the Radio .....</b>	<b>27</b>
4.1 Turning the Power ON and OFF .....	27
4.2 Setting the Volume .....	27
4.3 Setting the Squelch .....	28
4.4 Setting the Power Output .....	28
4.5 Setting the Channel .....	29
4.6 Selecting a Weather Channel (If Available) .....	29
Weather Alert Operation (If Available) .....	30
4.7 Setting the Frequency Band .....	30
4.8 Selecting Priority Mode .....	31
4.9 Selecting the Favourite (PLUS) Channel .....	32
Reprogramming the Favourite (PLUS) Channel .....	32
4.10 Transmitting .....	33
4.11 Turning On the Backlight .....	34
4.12 Turning On the Keylock .....	34
4.13 Using the Scan Modes .....	35
All Scan .....	35
Saved (Memory) Scan .....	36
Priority All Scan .....	37
Priority Saved Scan .....	37
4.14 Adding Channels to Memory .....	38
4.15 Using the Monitor Modes .....	39
Dual Watch .....	39
Tri Watch .....	40
4.16 USER Channel Mode .....	41
4.17 ATIS ID Number .....	42
Programming the ATIS ID Number .....	42
4.18 Resetting Factory Defaults .....	46
<b>Chapter 5: Customer Service .....</b>	<b>47</b>
5.1 How to Contact Raymarine .....	47
On the Internet .....	47
Customer Support .....	47
In Europe .....	47
Technical Support .....	48

---

Accessories and Parts .....	48
Worldwide Support .....	48
<b>Appendix A: Specifications .....</b>	<b>49</b>
<b>Appendix B: Channel List .....</b>	<b>51</b>
International VHF Marine Radio Channels & Frequencies .....	51
European Private Channels and Frequencies .....	54
U.S. VHF Marine Radio Channels and Frequencies .....	55
Canadian VHF Marine Radio Channels and Frequencies .....	58
WX Channels (North America only) .....	63
<b>Appendix C: Glossary .....</b>	<b>65</b>
<b>Index .....</b>	<b>67</b>



# About this Handbook

## Purpose

This handbook describes the Ray101E portable VHF marine radio. The Ray101E provides communications on all International marine channels, pre-set private channels, and (if programmed) all US and Canadian and marine channels.

## Conventions Used

Throughout this handbook, the dedicated (labelled) keys are shown in bold capitals (for example: **SCAN/SAVE**). The LCD indicators and functions are shown in normal capitals (for example: TX).

- Operating procedures, which may consist of a single key-press or a sequence of numbered steps, are indicated by an arrow icon shown in the margin.

## Technical Accuracy

To the best of our knowledge, the information in this handbook was correct as it went to press. However, our policy of continuous product improvement and updating may change specifications without prior notice. As a result, unavoidable differences between the product and handbook may occur from time to time. Raymarine cannot accept liability for any inaccuracies or omissions it may contain.

For the latest product information visit our website:

[www.raymarine.com](http://www.raymarine.com)

## Warranty

To register your new Raymarine product, please take a few minutes to fill out the warranty registration card found at the end of this handbook. It is very important that you complete the owner information and return the card to the factory in order to receive full warranty benefits.

# Important Information

## Intended Use

The Ray101E is a VHF radiotelephone that is intended for general communication within the Maritime Mobile Service worldwide and is for use on non-SOLAS vessels.

## Safety Warnings

### **CAUTION: Navigation Aid**

This unit is only an aid to navigation. Its accuracy can be affected by many factors, including equipment failure or defects, environmental conditions, and improper handling or use. It is the user's responsibility to exercise common prudence and navigational judgments. This radio should not be relied upon as a substitute for such prudence and judgment.



### **CAUTION: Battery and Charger Use**

- The battery charger is intended for use in 12 VDC systems only.
- Charge the batteries with the radio powered off for at least 24 hours before using the radio for the first time or if the radio has not been used in several months.
- Do not operate the radio in the charger when the battery tray is empty as this may damage the radio.
- Do not transmit with the radio in the charger.
- Do not short terminals in charger base.
- Do not place charger in water.
- Do not use charger if power plug or cable is damaged.
- Do not charge batteries with + and – terminals reversed.
- Do not recharge batteries if physically deformed or leaking.
- Do not charge anything other than AA-size Ni-MH cells in charger.
- Do not mix Alkaline and Ni-MH cells.
- Do not solder cells directly into battery tray.
- Do not dispose of cells in fire.
- Do not dismantle cells.
- Replace all cells at the same time.
- Store cells in a cool, dry place.

- 
- Charge and discharge under ambient temperature mentioned in cell's specifications.
  - Using batteries in extreme conditions (extreme temperature, deep cycle, extreme overcharge and over discharge, etc.) may affect their service life.



**WARNING: Alkaline Battery Use**

**When Alkaline cells are used, do not place radio in Charger unless Charge Switch on radio is set to ALKALINE. Charging Alkaline cells may cause excessive heat and could result in cell leakage causing damage or injury.**

## **EMC Conformance**

All Raymarine equipment and accessories are designed to the best industry standards for use in the recreational marine environment. Their design and manufacture conform to the appropriate Electromagnetic Compatibility (EMC) standards but correct installation and use is required to ensure that performance is not compromised.

Raymarine is a registered trademark of Raymarine UK Limited.

© Raymarine UK Limited 2005

Certificate No.

**RT042****Raymarine**  
ON BOARD

# EC Declaration of Conformity

*We* **Raymarine Limited****Anchorage Park  
Portsmouth  
Hampshire  
England PO3 5TD**

*declare, under our sole responsibility, that the products identified in this declaration, and to which this declaration relates, are in conformity with the essential requirements of European Parliament and Council Directive:*

*1999/5/EC on radio equipment and telecommunication terminal equipment and the mutual recognition of their conformity.*

Product Name:	<b>Raymarine RAY 101E Handheld VHF Radio</b>
Product Number(s):	<b>E43028</b>
Product Option:	<b>UK power converter</b>
Product Number:	<b>E46038</b>
Product Option:	<b>European power converter</b>
Product Number:	<b>E46041</b>

*The products have been assessed to Conformity Procedure Annex IV of the Directive and by application of all or part of the following standard(s):*

Non-Harmonised Standards(s): **EN 60945, EN 301 178-1, EN 300 698-1,**

*The satisfactory assessment of the above, allows a presumption of Conformity to the following Harmonised standards:*

Harmonised Standard(s): **EN 301 178-2, EN 300 698-2, EN 300 698-3**

*The assessment is consistent with a Technical Construction File showing conformity with the essential requirements of the Directive and has been reviewed by Notified Body No. 0168*

*The RAY 101E is labelled with the CE conformity marking, the identification number of the Notified Body and class identifier.*

Signatory:	Name	<b>Adil Abbas</b>
	Title	<b>International Compliance Manager</b>
	Company Name	<b>Raymarine Limited</b>
	Company Address	<b>Anchorage Park Portsmouth, Hampshire England PO3 5TD</b>

Signature

Date

\_\_\_\_\_  
**February 2004**

# Chapter 1: General Information

## 1.1 Introduction

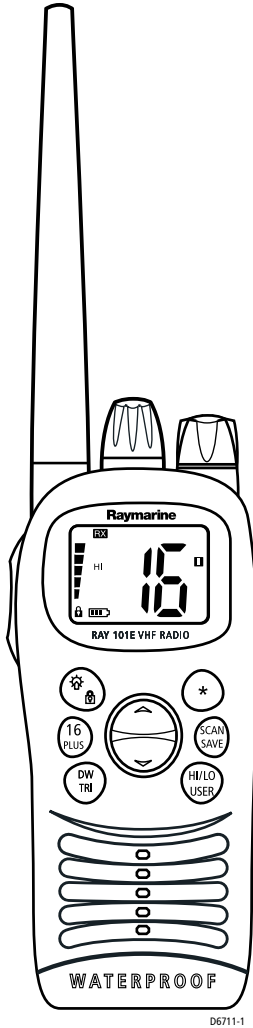

The Ray101E is a microprocessor-controlled, portable transceiver that provides reliable simplex (single frequency) and semi-duplex (two frequency) communications. This handbook describes the physical and functional characteristics of the radio.

The Ray101E provides communications on all International marine channels, pre-set private channels, and (if programmed) all US and Canadian and marine channels. Refer to the Frequency Tables in Appendix B, which list all marine VHF channels available in the radio. You should familiarize yourself with these tables as you are responsible for using the proper channels.

## 1.2 Features

The Ray101E is designed and manufactured to provide ease of operation with excellent reliability. The Ray101E features:

- Waterproof construction to IPX-7 standard
- Saved-channels Scan and Priority Scan
- ATIS operation, if required
- Private Channels (if so licensed)
- Dual/Tri Watch Monitor Modes
- Dedicated Priority Mode Key
- Programmable favourite Channel key
- Ni-MH Batteries, AA-size (included)
- Ni-MH Quick Charger (included)
- 12VDC Cigarette Lighter Adapter (included)

## **1.3 Licensing Requirements**

Regulations in some areas require that you obtain an operator license before operating VHF radio equipment. It is your responsibility to determine whether a license is required in your area before operating this equipment.

### **Automatic Transmission Identification System (ATIS)**

If needed, your Ray101E can activate the Automatic Transmission Identification System (ATIS) feature for use in the inland waterways of European countries that require automatic identification transmission. An ATIS ID number is required to operate the ATIS feature. Your ATIS number is derived from your vessel's call sign. Your authorized Raymarine dealer can assist you in decoding the number. You can then program the ATIS number into your Ray101E using the operation described in this handbook. If regulations in your area do not permit you to program the ATIS number yourself, you can have your authorized Raymarine dealer program the number for you.

# Chapter 2: Installation

## 2.1 Unpacking and Inspection

Use care when unpacking the unit from the shipping carton to prevent damage to the contents. It is also good practice to save the carton and the interior packing material in the event you must return the unit to the factory.

### Equipment Supplied

The following is a list of materials supplied with the Ray101E:

Table 2-1: Supplied Components

Part Number	Description
T43029	E43028 Ray101E with E46038 UK (D type) Power Adapter
T43030	E43028 Ray101E with E46039 AUS/NZ (C type) Power Adapter
T43031	E43028 Ray101E with E46041 European (B type) Power Adapter
R49086	Antenna
R49088	Battery Tray
R49089	Ni-MH Quick Charger Base
R49092	12VDC Cigarette Lighter Adapter <sup>1</sup>
R49097	Belt Clip
R49098	Wrist Strap
81230	Ray101E Handbook
—	Batteries, (6) AA Ni-MH (1300mAh)

<sup>1</sup> Connect Cigarette Lighter Adapter to 12VDC system only. Connecting to other voltage systems can damage the charger.

## 2.2 Attaching the Antenna

Rotate the antenna clockwise to securely fasten it to the threaded connector on the top of the radio.

**Note:** *Do not operate the radio or press PTT without an antenna attached.*

## 2.3 Using the Belt Clip

► **To attach the radio to the belt clip:**

Slip the Ray101E onto the belt clip so that the adapter button on the rear of the radio locks into the bottom of the slot on the belt clip.

► **To remove the radio from the belt clip:**

Rotate the radio 180° and pull up and away from the belt clip.

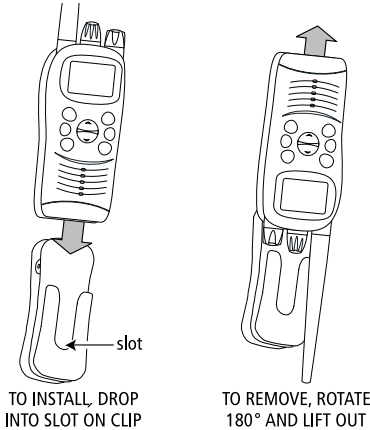

## 2.4 Attaching the Wrist Strap

1. Using the end of a paper clip, feed the narrow end of the strap through the two mounting holes at the top of the radio behind the antenna.
2. Continue feeding the strap through the loop and pull tight.

## 2.5 Battery Usage

The Ray101E can be powered by the supplied six (6) Nickel Metal Hydride (Ni-MH) batteries or with six (6) regular AA alkaline cells (not supplied), using the supplied Battery Tray.

## Battery Tray

- To open the Battery Tray and insert the battery cells:
1. Lift the fastener at the base of the unit and rotate counterclockwise  $\frac{1}{4}$  turn to the UNLOCK position.
  2. While holding the Ray101E in one hand, use the other hand to push the battery tray downward and then away to separate it from the back of the radio.

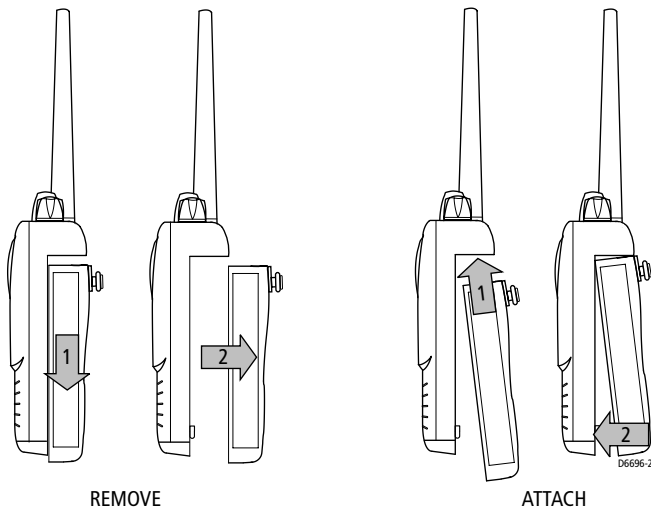

3. Lift up the tab located on the centre right side of the battery tray cover and remove it from the battery tray.
4. Locate the Battery Type switch just below the battery compartment and turn to the appropriate position: ALKALINE or Ni-MH.

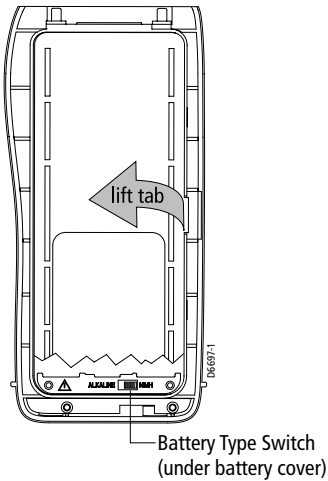

5. Noting the proper orientation, install the AA cells in three rows of two batteries each.
6. Replace the battery tray cover.



**WARNING: Alkaline Battery Use**

**When Alkaline cells are used, do not place radio in Charger unless Charge Switch on radio is set to ALKALINE. Charging Alkaline cells may cause excessive heat and could result in cell leakage causing damage or injury.**

7. Slide the battery tray up into the rear of the radio and then downward until it snaps into place.
8. Rotate the fastener at the base of the battery case clockwise  $\frac{1}{4}$  turn to the LOCK position.

**Note:** *The battery charger is intended for use in 12 VDC systems only.*

## Charging Rechargeable Ni-MH Cells



The Ni-MH batteries must be charged with the radio powered off for at least 24 hours before initial use. To charge the batteries:

1. Insert the radio with the battery tray attached into the Ni-MH charger unit.
2. Connect the AC wall adapter into a standard wall outlet.

—or—

Connect the Cigarette Lighter Adapter into a standard 12VDC Cigarette Lighter.

3. Insert the moulded plug into the connector on the side of the battery charger.

The CHARGE indicator LED on the front of the charger lights when it is receiving voltage from the AC adapter.

### CAUTION:

1. Make sure the switch just below the battery compartment is set to the Ni-MH position.
2. Do not operate radio in charger when battery tray is empty. This may damage radio.
3. Do not transmit with the radio in the charger as this may damage the radio.

Charge the batteries with the radio powered off for at least 24 hours before using the radio for the first time or if the radio has not been used in several months.

Under normal use, you can charge the batteries while the radio is powered on. With heavy usage, however, the radio should be powered off to maximize charging efficiency. Normal use is defined as a duty cycle of 5% receive and 95% standby time.

## Charger LED

The following describes status of the charger's LED when it is receiving voltage from the adapter:

LED Color	Status
RED	<ul style="list-style-type: none"> <li>Batteries are charging (fast charge)</li> </ul>
AMBER/ ORANGE <sup>1</sup>	<ul style="list-style-type: none"> <li>Input power is too low and the charger has turned off, or</li> <li>Input power is too high and the charger has turned off.</li> </ul>
GREEN <sup>2</sup>	<ul style="list-style-type: none"> <li>Batteries are fully charged and the charger is maintaining a trickle charge, or</li> <li>Battery tray is empty and unit is not charging, or</li> <li>Battery Type Switch is set to ALKALINE and unit is not charging, or</li> <li>Charger is in Standby Mode and is not charging</li> </ul>

<sup>1</sup> If the charger LED turns AMBER/ORANGE, you should disconnect the charger and investigate the reason for the overvoltage or undervoltage condition.

<sup>2</sup> To protect the batteries, the charger remains in Standby Mode (not charging) if the batteries are too cold or too hot (hot to the touch). During this time, the unit does not charge and the LED remains green.

Before initial use, apply power to the charger with the radio removed. Check the status of the charger's LED before inserting the radio:

- If the LED is green, the input voltage is OK. Insert the radio into the charger. The LED should turn red, indicating that the batteries are being charged.
- If the LED is amber/orange, there is an undervoltage or overvoltage condition in the boat's power system. Disconnect the charger and investigate the reason for the power problem before inserting the radio.

During initial charging or if charging when the radio has not been used in several months, the LED may turn green prematurely (before the batteries are fully recharged). Continue to charge the batteries for a full 24 hours even if the LED turns green before this 24 hour period has expired.

If you suspect that the LED may have turned green prematurely, you can perform a test by powering on the radio, switching to high power and holding the PTT switch for 1 second. If the Battery Level indicator loses segments in the bar graph, the batteries are not fully charged.

After the initial charge, it takes about 2 hours to recharge spent batteries and for the LED to turn green.

**Note:** *Purchase an additional battery tray and extra batteries so that you will always have spare charged batteries available.*

## **Storage**

It is normal for any battery cell to lose charge even when it is not being used.

Before storing the radio for 6 months or more:

- Fully charge the batteries to help ensure that the cells do not experience a deep discharge while they are in storage.
- Remove the Battery Tray from the radio and then remove the batteries from the Battery Tray to help prevent internal current leakage that can result in corrosion.
- Store the batteries in a cool, dry place to further minimize current leakage.

After storage, multiple charge/recharge cycles may be required before maximum capacity is restored.



# Chapter 3: Getting Started

## 3.1 Keypad and Rotary Knobs

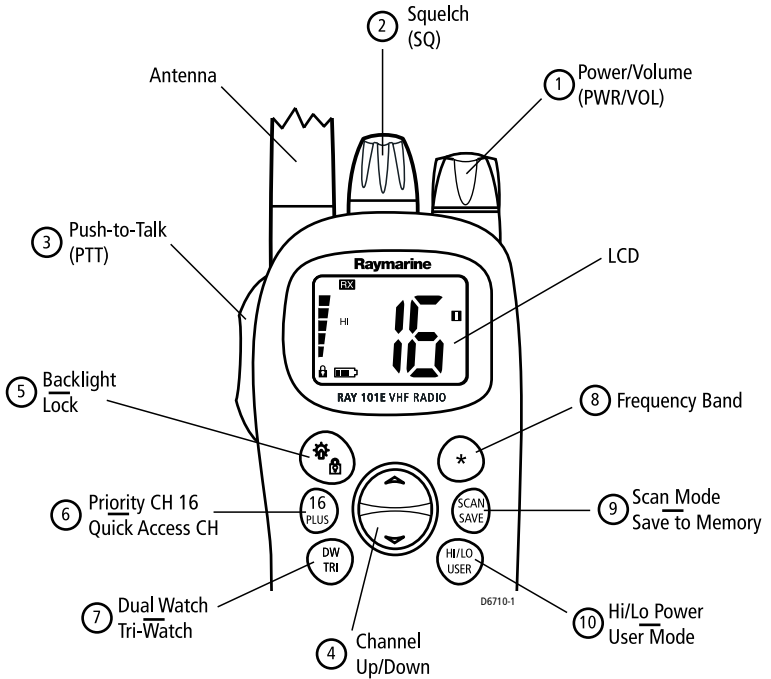

Several of the keys on the front panel of the base station serve multiple purposes. For the most part, the function indicated on the first line of the key is accessed by pressing and releasing that key. The function indicated on the second line of the key is accessed by pressing and holding the key for three seconds.



## Rotary Keys

Key Name	Function
1. PWR/VOL	Power radio ON / OFF and adjust volume level
2. SQ	Adjust squelch threshold level

## Push Keys

Key Name	Press & Release (<3 sec)	Press & Hold (>3 sec)
3. PTT	Push to talk	Push to talk
4. UP/DOWN	Channel increment / decrement	Rapid channel change
5.  	Backlight ON/OFF	Keylock ON/OFF
6. 16/PLUS	Switches between Priority and Working Channels	Switches to favourite (PLUS) channel; If already tuned to the PLUS channel, programs a new PLUS channel.
7. DW / TRI	Dual Watch Mode	Tri Watch Mode
8. *	n/a	Select frequency band (if available)
9. SCAN / SAVE	Scan ON/OFF	SAVE/DELETE channel to/from memory
10. HI/LO / USER	TX Power High/Low	USER (Saved Memory Channel) Mode

## Description



### 1. PWR/VOL

Use this knob to turn the radio ON and OFF and to set the volume.



### 2. SQ

Use this knob to set the squelch threshold, which cuts off the receiver when the signal is too weak for reception of anything but noise.



### 3. PTT

While pressing this Push-To-Talk key radio transmission is enabled.



#### 4. UP/DOWN

Use the arrow keys to change the current channel number. Press and hold for rapid channel changing.



#### 5. Backlight / Keylock

Press and release this key to toggle on and off the display's backlight. Press and hold to toggle the keylock function, which protects the radio from any keypad entry.



#### 6. 16/PLUS

Press and release this key to toggle on and off Priority Mode, in which the radio switches to Priority Channel 16 at high power. Press and hold to switch to the Favourite (PLUS) Channel. If already in Priority Mode, press and hold to change the Favourite (PLUS) Channel.



#### 7. DW/TRI

Press and release this key to toggle on and off Dual Watch, in which the radio monitors the current working channel and CH 16 in cycle. Press and hold to toggle on and off Tri Watch, which monitors CH 16, the current working channel and the channel you have set as the Favourite (PLUS) Channel in cycle.



#### 8. Frequency Band (\*)

Press and hold this key to alternate the frequency band between the USA, International and Canadian channel sets (if available).



#### 9. SCAN / SAVE

Press and release this key to toggle on and off Scan Mode. Press and hold to save a channel into the radio's memory.



#### 10. HI/LO / USER

Press and release this key to toggle the transmit power between HIGH and LOW. Press and hold to enter User Channel Mode, which displays only the channels that you have saved to memory.

### 3.2 LCD Display

The following describes the functional characters on the Ray101E's LCD.

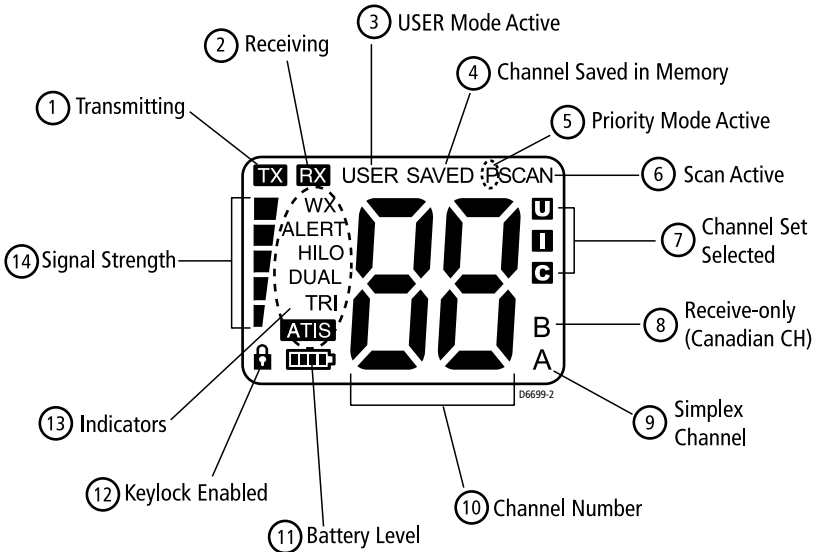

#### 1. (TX) Transmitting

Indicates the PTT is being pressed and the radio is transmitting.

#### 2. (RX) Receiving

Indicates that the radio is receiving a radio signal. If the radio receives a signal but the squelch threshold is set so high that the signal cannot be heard, the RX indicator is not displayed but the bar graph on the left side of the LCD is illuminated to show the appropriate signal strength.

#### 3. (USER) Favourite Channel Mode

Indicates the radio is in USER Mode. USER Mode displays only the channels that you have saved to memory, enabling you to easily scan your favourite channels while bypassing unwanted or seldom-used channels.

## 4. (SAVED) Memory Mode

Indicates the current channel has been saved in memory. Appears during Saved Scan mode. Only saved channels are scanned during USER mode.

## 5. (P) Priority Mode

P appears during Priority Mode, when the **16PLUS** key is pressed. Also appears with PSCAN during Priority Scan mode.

## 6. (SCAN) All Scan/Saved Scan/Priority Scan

SCAN appears during All Scan and Saved Scan. (SAVED also appears during Saved Scan mode.) PSCAN appears during Priority Scan mode.

## 7. (U I C) Channel Set

Indicates which channel group set is currently selected: **US**, International or **Canadian**.

**Note:** *US and Canadian channels are available only if your radio has been programmed to receive them. Special licensing is required to receive the US and Canadian channel sets.*

## 8. (B) Receive-only Channel

Indicates that you cannot transmit on the currently-selected channel; it is receive-only. Used with Canadian channels only.

## 9. (A) Simplex Channel

Indicates that the currently-selected channel is simplex in US and Canadian channels but duplex in the International channel set. Simplex means you transmit and receive on the same frequency. Used with US and Canadian channels only.

## 10. Channel Number

Displays the current channel number.

## 11. Battery Level

Indicates current battery strength. Greater battery strength displays a larger number of segments in the bar graph.

 Fully charged

 Normal operation

 Normal operation

 Needs charging

## 12. Keylock

Indicates the radio is protected from any keypad entry except for PTT and the backlight function.

## 13. Indicators

Indicates special conditions:

### **(WX) Weather Channel**

Weather channel mode is active. US and Canada only.

### **(ALERT) Weather Alert**

A weather alert is being received. US and Canada only.

### **(HI/LO) TX Power**

Indicates whether transmit power is set for 5 watts (HI) or 1 watt (LO).

### **(DUAL) Dual Watch**

Indicates the radio is in Dual Watch mode.

### **(TRI) Tri Watch**

Indicates the radio is in Tri Watch mode.

### **(ATIS) ATIS Active**

Indicates that Automatic Transmitter Identification System (ATIS) transmission is enabled. For use on the inland waterways of certain European countries only. See "ATIS ID Number" on page 42.

## 14. Signal Strength



Displays the relative strength of the TX and RX signals.

When the output power is set for 5 watts, the full scale (5 bars) is displayed during transmission.

When transmit output power is set for 1 watt, only two bars are displayed during transmission.

When receiving, the bar graph indicates the strength of the signal being received. A stronger signal displays a larger number of segments in the bar graph.

# Chapter 4: Operating the Radio

## 4.1 Turning the Power ON and OFF

Turn the **PWR/VOL** knob clockwise until it clicks.

When the unit powers up in Normal mode it:

1. Beeps, illuminates the backlight at full brightness, and displays all segments and indicators for 2 seconds.
2. Displays the software version number on the LCD but without the decimal point. For example, version 4.2 would appear as 42.
3. Recalls the last CH number, TX power settings and operation mode. If no last-used setting data exists, goes to CH 16 and high TX Power.

► To turn the unit OFF:

Rotate the Volume knob completely counter clockwise until it clicks.

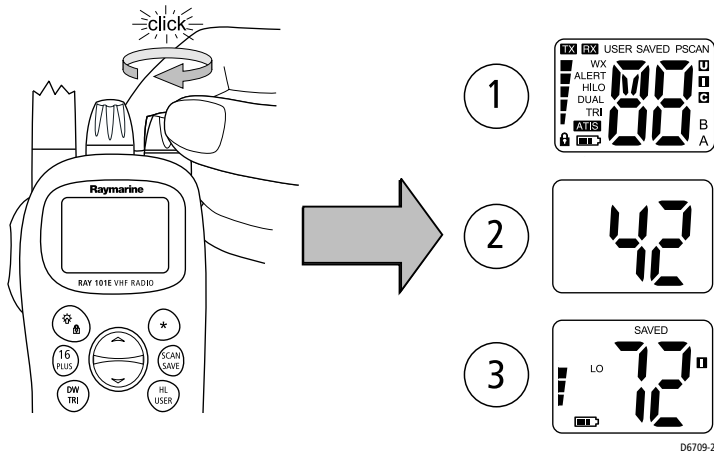

## 4.2 Setting the Volume

Adjust the **PWR/VOL** knob to control the loudspeaker volume level. Turn clockwise to increase the volume; counter clockwise to decrease the volume.

**Note:** Key press beep volume is also controlled by the VOL level.

### 4.3 Setting the Squelch

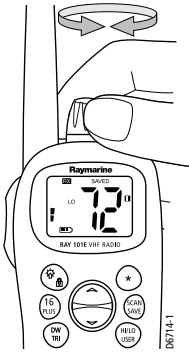

The Squelch circuit sets the threshold for cutting off the receiver when the signal is too weak for reception of anything but noise.

To properly set the squelch, rotate the **SQ** knob counter clockwise until noise is heard.

Then rotate clockwise until background noise disappears.

### 4.4 Setting the Power Output



Press and release the **HI/LO / USER** key to toggle the TX power from LOW (1 watt) to HIGH (5 watts). The corresponding LO or HI indicator appears on the LCD.

Initial contact should always be attempted using low power. You should switch to high power only when contact can not be made on low power in emergency situations. This procedure is part of marine communications courtesies and will save on battery life.

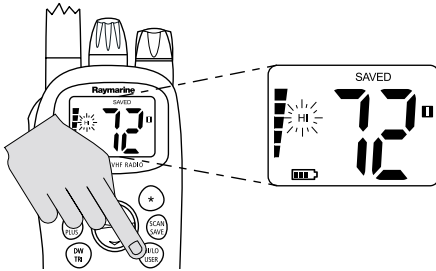

Press and release

**Note:** Some channels are limited by regulation to be low power only. If the HI/LO operation request is denied, an error tone beeps.

## 4.5 Setting the Channel

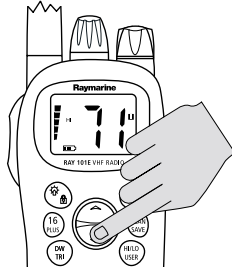

Press and release the UP arrow to increment the channel number.

Press and release the DOWN arrow to decrement the channel.

Press and hold either key for rapid channel scrolling.

## 4.6 Selecting a Weather Channel (If Available)



The US National Oceanic and Atmospheric Administration (NOAA) broadcasts continuous weather reports and severe weather alerts, as needed. If so equipped, your Ray101E is programmed to receive 10 NOAA weather channels and sound an alarm if a weather alert is received.

Press and release the \* key to enter Weather mode. The WX indicator appears. Press Channel UP/DOWN to change the WX channel 1 through channel 10.

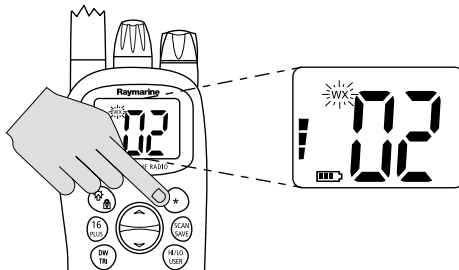

Press and release

Press and release the \* key again to return to normal operation.

**Note:**

1. *Weather broadcasts can only be heard in the North America.*
2. *The Ray101E can receive these broadcasts only if the unit has been upgraded by the distributor to use WX Channels.*
3. *During Weather mode, the PTT, SCAN/SAVE and HI/LO / USER keys are disabled and an error beep sounds if pressed.*

## Weather Alert Operation (If Available)

Weather Alert is toggled ON and OFF by pressing and holding \* key in the weather mode. The ALERT icon illuminates.

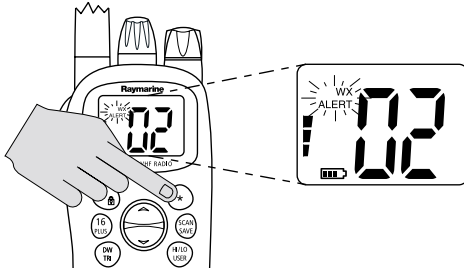

Press and hold

When Weather Alert function is enabled and the radio is tuned to the normal working channel, the last-used weather channel is checked every 30 seconds for weather alert tone. If the alert tone is detected, the WX and ALERT indicators flash and a short alarm tone sounds.

The radio automatically turns to the currently-monitored WX channel where the weather alert has been detected. The alert is detected in all modes of operation (Standby, Dual and Tri Watch, Scan, etc.)

**Note:** *The Ray101E can receive weather alert broadcasts in the US or Canada only if the unit has been upgraded by the distributor to use WX Channels.*

## 4.7 Setting the Frequency Band

\*

The Ray101E can transmit and receive on all available US, Canadian and International marine VHF radiotelephone channels, if available.

Press and hold the \* key for greater than 3 seconds while in normal operation mode to alternate between the International, US and Canadian channel sets. The appropriate indicator is illuminated in the LCD: U for US, I for International, or C for Canadian channel sets.

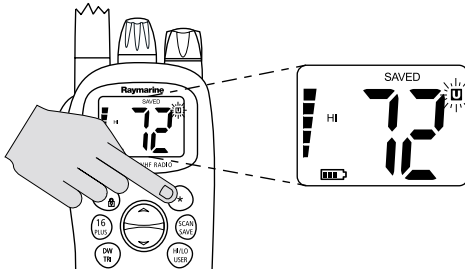

Press and hold

**Note:** The RAY101E requires a software upgrade from the distributor to communicate on the US or Canadian channel sets. Some countries require special licensing to activate the US or Canadian channels.

If no other Channel Sets besides International have been programmed for your Ray101E by the distributor, an error tone sounds when you press the \* key.

## 4.8 Selecting Priority Mode



The Ray101E provides you with a dedicated key for selecting Priority Mode, which instantly switches the radio to Priority Channel 16 at high power.

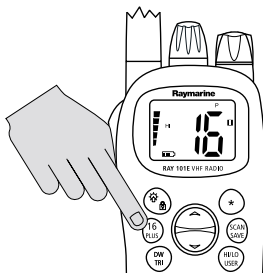

Press and release

If not already tuned to the Priority Channel 16, press and release the **16/PLUS** key to place the radio into Priority Mode. While in this mode, the radio is switched to CH16 at high power. The P and HI indicators appear on the LCD.

**Note:** When you press the 16/PLUS key, the radio always switches to HIGH power. You can use the HI/LO / USER key to change to LOW power.

The following describes the results of pressing the various keys during Priority Mode:

- **16/PLUS.** Press and release to return to the last-used working channel. Press and hold to switch to the Favourite (PLUS) Channel.
- **\***. Press and hold to switch to the other channel sets (if available). The radio remains in Priority Mode even though it switches frequency sets.
- **SCAN / SAVE.** Press and release to initiate Scan Mode. When you press again, the scan halts and the radio returns to Priority Mode. Press and hold to save CH16 into memory but remain in Priority Mode.

- **HI/LO / USER.** Press and release to reduce to low power but remain in Priority Mode. Press and hold to enter User Mode. The radio switches to the last-used User Mode channel but exits Priority Mode.
- **DW / TRI.** This key is not available during Priority Mode and an error tone sounds if pressed.

## 4.9 Selecting the Favourite (PLUS) Channel

16  
PLUS

The Ray101E enables you to program the **16/PLUS** key to switch to a Favourite (PLUS) Channel. The default is CH 9.



Press and hold

If on a working channel, press and hold the **16/PLUS** key for greater than 3 seconds to switch to the Favourite (PLUS) Channel at high power. The default is CH 9.

If on Priority CH16, press and hold the **16/PLUS** key for greater 3 seconds to switch to the Favourite (PLUS) Channel at HI power. The default is CH 9.

If already on Favourite (PLUS) Channel, press and release the **16/PLUS** key to switch to Priority Channel 16 at high power.

## Reprogramming the Favourite (PLUS) Channel

1. Switch to the Favourite (PLUS) Channel.
2. Press and hold the **16/PLUS** key for greater 3 seconds to switch to Reprogram mode. An alert tone sounds and the current Favourite (PLUS) Channel flashes.
3. Change the channel number with the UP and DOWN arrow keys.
4. Press and release the **16/PLUS** key to save the new Favourite (PLUS) selection. An alert tone sounds to indicate that the Favourite (PLUS) has been changed.

**Note:** While reprogramming the Favourite (PLUS) Channel, the PTT, DW/TRI and \* keys are disabled and an error beep sounds.

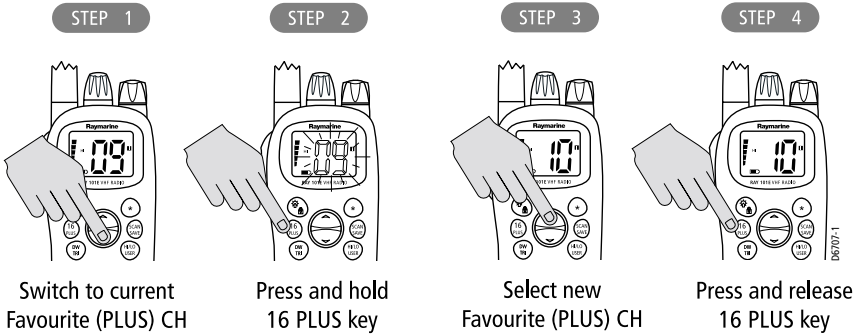

### 4.10 Transmitting



Press and hold the Push-To-Talk (**PTT**) key to transmit on the selected channel, then release to receive. The TX indicator appears while transmitting.

The radio is equipped with a timeout timer as per regulatory requirements. After **PTT** has been held continuously for 5 minutes, transmission is discontinued and the radio automatically returns to receive mode. An Error beep is emitted 10 seconds before the time out is triggered and TX flashes on the display until **PTT** is released.

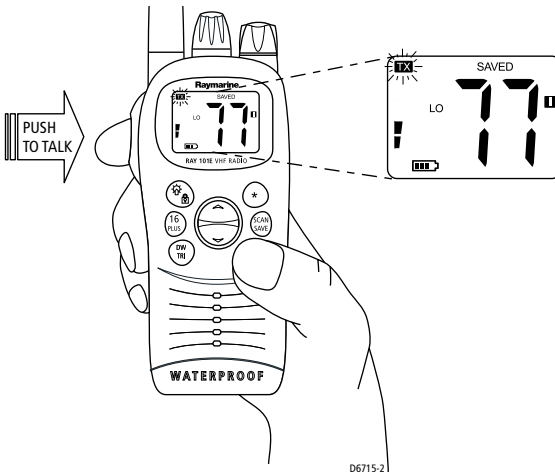

The TX time out timer is reset once the **PTT** key is released.

**Note:** If the current channel is a TX-prohibited channel, an alarm sounds when PTT is pressed, indicating such a transmission is not permitted.

### 4.11 Turning On the Backlight



To toggle the display's Backlight ON or OFF, press and release the  key.

When the Backlight setting is enabled, any key press except **PTT** turns on the backlight for 5 seconds. If a key is pressed within the time frame, the time out is reset.

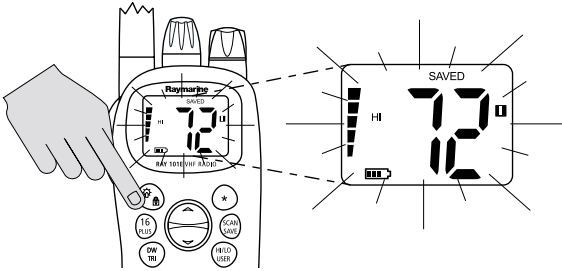

Press and release

### 4.12 Turning On the Keylock



To toggle the Keylock ON or OFF, press and hold the  key for 3 seconds. When Keylock is enabled, the lock icon appears on the display.

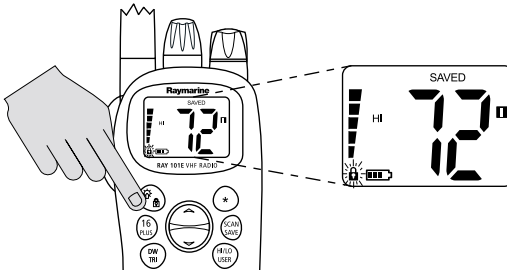

Press and hold

The Keylock setting protects the radio from any keypad entry except for **PTT** and the backlight function.

Then, press and hold the  key again for 3 seconds to cancel the keylock.

## 4.13 Using the Scan Modes



The RAY101E is equipped with three types of scan options: All Scan, Saved (Memory) Scan and Priority Scan. If there are no channels in memory, the default is All Scan.

This function automatically searches for transmissions on the channel set being scanned. If a TX signal is received, the scan stops on the receiving channel as long as it is present and the SCAN indicator flashes. If the signal is lost for five seconds, the radio resumes scanning.

During the Scan Modes:

- Press the Channel UP/DOWN key to change the scan direction. UP increments the channel while DOWN decrements it.
- Press and release **SCAN/SAVE** to terminate the SCAN mode.
- **DW/TRI** and **\* keys** do not function and sound an error beep if pressed.

**Note:** *Scan modes are disabled when the ATIS operation is active.*

### All Scan

Press and release the **SCAN/SAVE** key when no channels are stored in memory to activate the All Scan function.

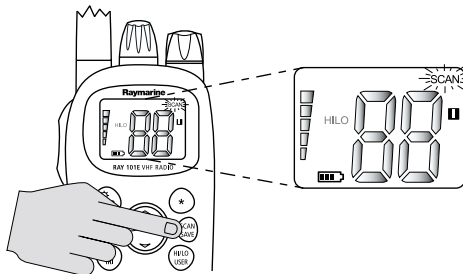

Press and release

The SCAN indicator appears on the LCD during All Scan.

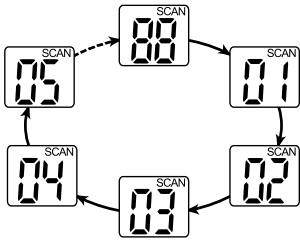

In All Scan mode, all channels in the channel set are scanned in sequence, assuming no channels have been stored in memory. After the last channel number has been scanned, the cycle repeats.

All Scan is demonstrated in the figure to the left (including Private Channel M1).

### Saved (Memory) Scan

Press and release the **SCAN/SAVE** key when there is at least one channel in memory to activate the Saved Scan function.

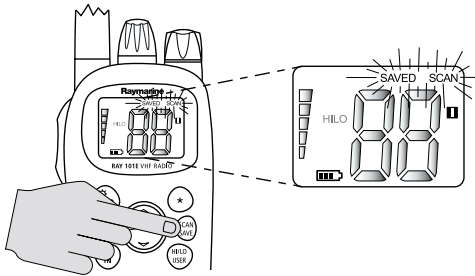

Press and release

In Saved Scan Mode, the **SAVED** and **SCAN** indicators appear on the LCD.

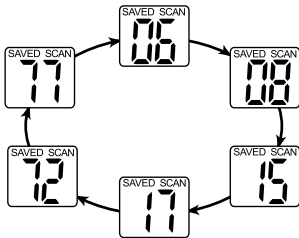

In Saved Scan mode, only the channels that have been saved in memory are scanned in sequence. After the last saved channel number has been scanned, the cycle repeats.

Saved Scan is demonstrated in the figure to the left.

### Priority All Scan



Press and hold the **SCAN/SAVE** key while All Scan is active to initiate Priority Scan.

During Priority Scan, the PSCAN indicator appears on the LCD.

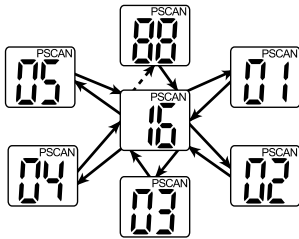

Priority Scan searches for activity on all channels but alternates scanning the Priority Channel 16 after each channel.

Priority Scan is demonstrated in the figure to the left. This example includes Channel M1, which is only used in the UK.

### Priority Saved Scan

Press and hold the **SCAN/SAVE** key while Saved Scan is active to initiate Priority Saved Scan.

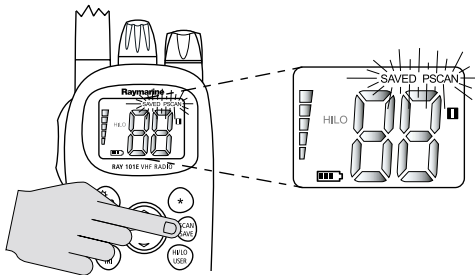

Press and hold

The PSCAN and SAVED indicators appear on the LCD.

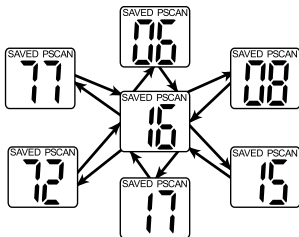

Priority Saved Scan is much like Priority Scan except that the radio alternates searching for activity on the Priority Channel 16 and the channels stored in memory.

Priority Saved Scan is demonstrated in the figure to the left.

Press and hold **SCAN/SAVE** for 3 seconds to exit Priority/Priority Saved Scan and return to All/Memory Scan.

## 4.14 Adding Channels to Memory



The Ray101E can store any channel (including Private Channels). The stored channels are the ones scanned in the Saved (Memory) Scan mode.

► To add channels to memory:

1. During normal operation mode, use the UP/DOWN key to select the desired channel for programming.
2. Press and hold the **SCAN/SAVE** key for 3 seconds.

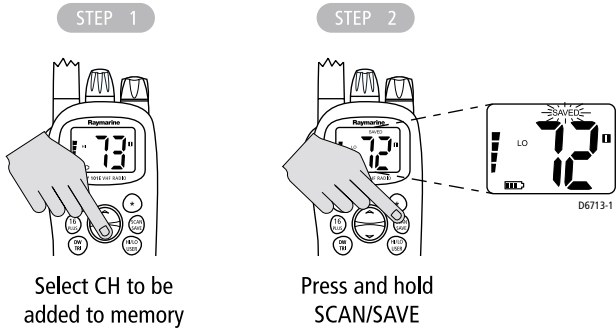

The **SAVED** icon appears to indicate the current channel has been saved in memory. Any number of channels can be saved as memory channels.

► To delete channels from memory:

1. During the normal mode, use the UP/DOWN key to select the channel to be deleted.
2. Press and hold the **SCAN/SAVE** key for 3 seconds.

The selected channel is deleted from memory.

To view the channels set in memory, switch to **USER** mode, as described in *Section 4.16, USER Channel Mode*.

## 4.15 Using the Monitor Modes



The Watch Modes monitor the programmed Priority Channel and other user-selected channel(s). The watch is halted when activity is detected on a monitored channel. The Ray101E is equipped with 2 types of monitor operations: Dual Watch and Tri Watch.

**Note:** *Monitor modes are disabled when the ATIS operation is active.*

### Dual Watch

Press and release the **DW/TRI** key to activate the Dual Watch mode.

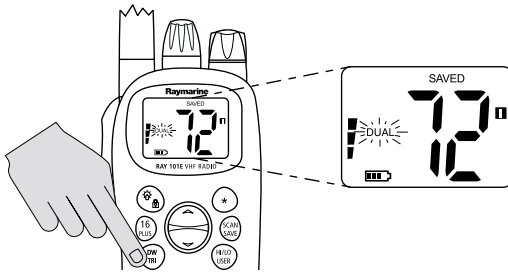

Press and release

The DUAL indicator appears on the LCD.

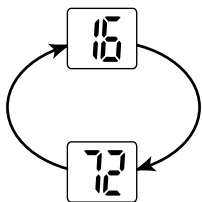

Dual Watch monitors the current working channel and Channel 16 in cycle.

Dual Watch is demonstrated in the figure to the left; the sample working channel is CH 72.

Press and release the **DW/TRI** key to terminate Dual Watch and return to the previous working channel.

Press and hold the **DW/TRI** key to terminate Dual Watch mode and go into Tri Watch mode.

Press and release the **16/PLUS** key to terminate Dual Watch mode and switch to the Priority Channel.

**Note:** *During Dual Watch mode, the SCAN/SAVE, USER, \*, and Channel UP/DOWN keys are inactive and sounds an error beep if pressed.*

## Tri Watch

Press and hold the **DW/TRI** key for 3 seconds to activate Tri Watch mode.

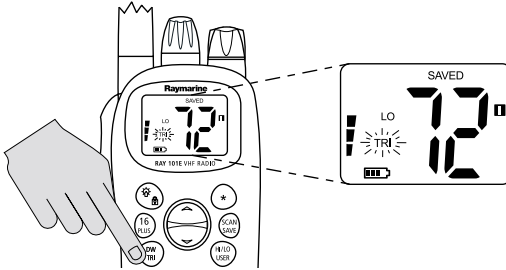

Press and hold

The TRI indicator appears on the LCD.

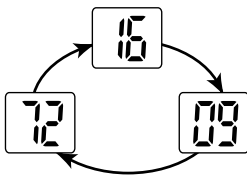

Tri Watch monitors in cycle Channel 16, the current working channel and the channel you have set as the Favourite (PLUS) Channel.

Tri Watch is demonstrated in the figure to the left; the sample working channel is CH 72.

Press and release the **DW/TRI** key to terminate Tri Watch and return to the previous working channel.

Press and release the **16/PLUS** key to terminate Tri Watch mode and switch to the Priority Channel.

**Note:** During Tri Watch Mode, the *SCAN/SAVE*, *USER*, *\**, and *Channel UP/DOWN* keys are inactive and sounds an error beep if pressed.

## 4.16 USER Channel Mode



Press and hold the **HI/LO / USER** key while in normal operation mode to enter User Mode. The USER and SAVED indicators appear.

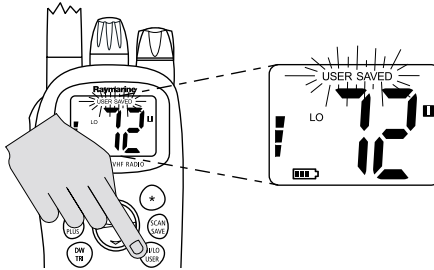

Press and hold

USER Channel Mode displays only the channels that you have saved to memory, which enables you to easily use your favourite channels while bypassing unwanted or seldom-used channels during a scan.

**Note:** *The procedure for saving a channel to memory is outlined in Section 4.14, Adding Channels to Memory.*

While in User Mode:

- Press and release the **SCAN/SAVE** key to start Memory Scan mode.
- Press and release the Channel UP or Channel DOWN key to scroll through the saved channels.
- Press and hold the **SCAN/SAVE** key to delete the current channel from memory list.
- Press **16/PLUS** to terminate User mode and switch to the Priority Channel.

**Note:** *You cannot switch Channel sets while in User Mode. The \* key does not function and sounds an error beep if pressed.*

Press and hold the **HI/LO / USER** key for 3 seconds to quit User mode and return to the last-used working channel.

## 4.17 ATIS ID Number

If you purchased your Ray101E to include use on the inland waterways of the contracting governments of the Basel Agreement, your radio has been programmed by your dealer to include Automatic Transmitter Identification System (ATIS) functionality. The Basel Agreement includes Germany, Austria, Belgium, Bulgaria, Croatia, France, Hungary, Luxembourg, Moldova, the Netherlands, Poland, Romania, Russian Federation, the Slovak Republic, Switzerland, the Czech Republic, Ukraine and the Federal Republic of Yugoslavia.

ATIS includes data at the end of radio transmission that identifies your station. Your ATIS ID number is derived from your vessel's call sign. Your authorized Raymarine dealer can assist you in decoding the number. You can then program the ATIS number into your Ray101E using the operation described in this section.

Regulations in some regions may not allow end users to program their own ATIS number. If this unit was purchased to be used in such a region, this function will be disabled and the programming must be done by your authorized Raymarine dealer/distributor.

**Note:** *The ATIS ID is a ten digit number that always begins with a "9". You will only enter the last nine digits; the first 9 is automatically entered for you.*

### Programming the ATIS ID Number

1. With the radio powered OFF, simultaneously press and hold the  key and the \* key.
2. While still depressing the two keys, turn ON the radio.

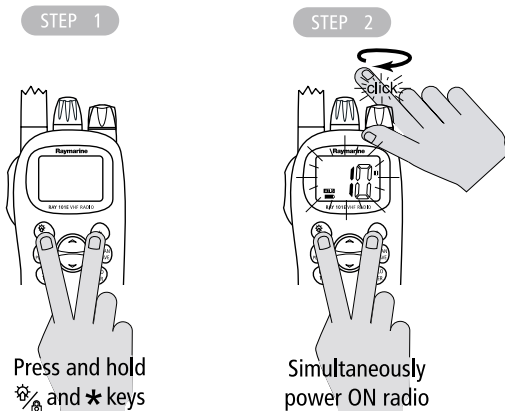

The ATIS ID programming screen is displayed.

The left digit indicates the digit position of the ATIS ID; the right digit, which blinks continuously, indicates the value of that digit.

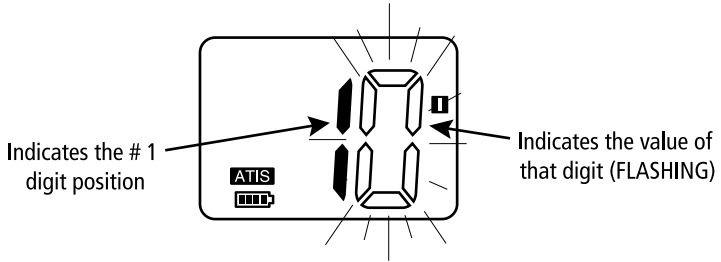

3. Use the CH UP/DOWN key to change the first digit to the correct value for your particular ATIS ID.

The ATIS ID is a ten digit number that always begins with a "9". You will only be entering the last nine digits; the first "9" is automatically entered for you. So, although it is technically the second number in the sequence, it is the first digit you will be entering.

For example, if your ATIS ID = 9 244 03 8 0 7 5 and remembering that the initial "9" has already been entered for you, press CH UP/DOWN until the "2" appears, as follows.

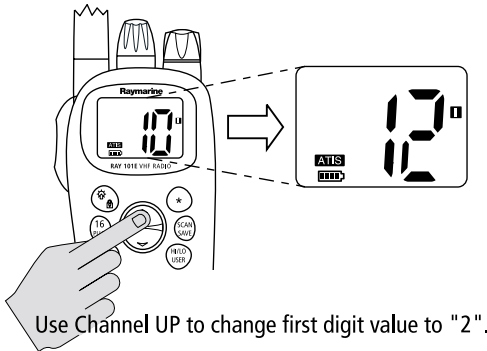

4. When the correct value is flashing, press **SCAN/SAVE** key for 3 seconds to confirm the selection.  
The next digit position and its value appear.

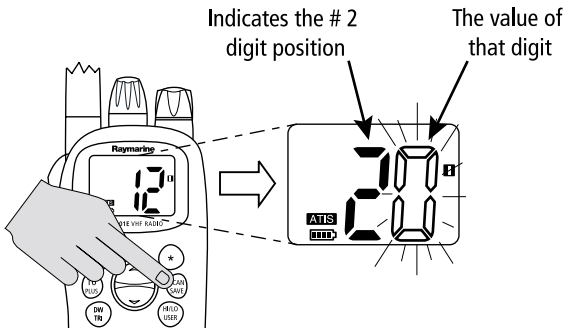

Press and hold SCAN/SAVE. The next digit set appears.

5. Press CH UP/DOWN to change the second digit to the correct value. Using our example of ATIS ID = 9 244 03 8 0 7 5, press CH UP/DOWN until the 4 appears.

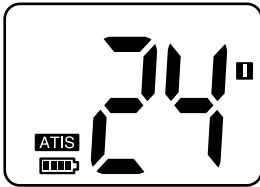

6. Continue this process until all nine ATIS numbers have been entered.

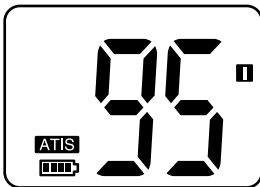

7. You must now re-enter the ATIS ID a second time to confirm. After entering a valid ATID ID for the second time, the radio flashes its complete ATIS ID. The nine ATIS ID number pairs are flashed in sequence, one set at a time on the screen.

In our example, the sequence would be:

1 2  
2 4  
3 4  
4 0  
5 3  
6 8  
7 0  
8 7  
9 5

When complete, the radio returns to the last-used mode. If no channel is found in the memory, the radio reverts to CH 16 at High Power setting.

If a different ATIS ID is entered the second time, the operation is cancelled and a long alarm tone is sounded.

8. Store the ATIS ID permanently into the radio by turning the radio OFF.

To exit ATIS programming mode without saving, press the **16/PLUS** key at any time to jump to priority Channel 16.

**Note:** *After this programming, only your distributor can modify or erase the ATIS ID.*

## 4.18 Resetting Factory Defaults

You can reset many radio settings back to their factory defaults:

- Erase any channels stored in memory
- Return to International channels, if another mode is selected
- Turn OFF the Weather Alert setting, if active
- Return power settings to their original state

► To perform the reset:

1. Turn the radio OFF.
2. Simultaneously press and hold the **HI/LO / USER** and **\***  keys.
3. While continuing to hold these keys, power the radio ON.

The LCD remains blank for 2 seconds, and then the unit switches to channel 16.

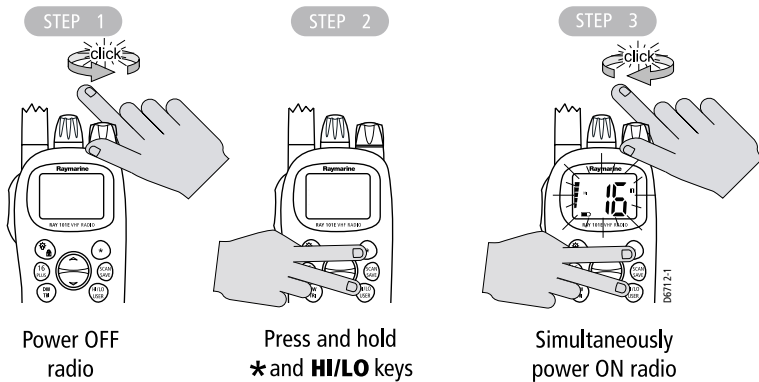

# Chapter 5: Customer Service

This chapter provides information on service for your Ray101E.

## 5.1 How to Contact Raymarine

### On the Internet

Visit the Raymarine World Wide Web site for the latest information on Raymarine electronic equipment and systems at:

[www.raymarine.com](http://www.raymarine.com)

### Customer Support

Navigate to the Customer Support page for links for:

- Finding Factory Service locations and Authorized Dealers near you
- Registering your Raymarine products
- Accessing handbooks in Adobe Acrobat format
- Downloading RayTech software updates
- Accessing the Raymarine solution database

Clicking the Find Answers link routes you to our solution database. Search questions and answers by product, category, keywords, or phrases. If the answer you are seeking is not available, click the Ask Raymarine tab to submit your own question to our technical support staff, who will reply to you by e-mail.

### In Europe

In Europe, Raymarine support, service and accessories may be obtained from your authorized dealer, or contact:

Raymarine Ltd  
Anchorage Park  
Portsmouth, Hampshire  
England PO3 5TD  
Tel: +44 (0) 23 9269 3611  
Fax: +44 (0) 23 9269 4642

## **Technical Support**

The Technical Services Department handles inquiries concerning installation, operation, fault diagnosis and repair. For technical helpdesk contact:

Tel: +44 (0) 23 9271 4713

Fax: +44 (0) 23 9266 1228

## **Accessories and Parts**

Raymarine accessory items and parts are available through your authorized Raymarine distributor. Please refer to the lists of component part numbers and optional accessories in the Installation chapter of this manual and have the Raymarine part number ready when speaking with your dealer.

If you are uncertain about what item to choose for your unit, please contact our Customer Services Department prior to placing your order.

## **Worldwide Support**

Please contact the authorized distributor in the country.

# Appendix A: Specifications

## General

Approvals: CE - conform to	EN301 178-2, EN300 968-2, -3
Size (H x W x D)	5.55" (141mm) x 2.4" (61mm) x 1.69" (43mm) without antenna
Weight	0.36 kg (12.8 oz)
Power Source	7.2V DC (6 x AA Alkaline or AA Ni-MH Batteries)
Environmental: Operating Range: Storage Range: Humidity:	Waterproof to IPX7 -15°C to +55°C (+5°F to 131°F) -20°C to +70°C (-4°F to +158°F) up to 95% at 35°C non-condensing
Frequency Range: Transmit Receive	156.025 To 157.425 MHz 156.050 To 163.275 MHz
Channels	55 International VHF Marine Band. 50 US and 60 Canadian channels also available if so programmed. Also, 10 Weather Channels (with weather alert), if so programmed (North America only).
Modulation	FM 16K0G3E
Channel Spacing	25 kHz Increments
Antenna Socket	SMA
Display	38.4mm x 48.3mm LCD
Built in Speaker	Ø40mm / Impedance 8 Ohm

## Receiver

Sensitivity (12dB SINAD)	0.30µV
Squelch Sensitivity (threshold)	10 (± 2) dB SINAD
Audio Output Power At THD 5%	>= 250 mW
Max S/N ratio @ 1 mV	40 dB
Audio Response	@300Hz + 6 dB ± 3 @2500Hz -11 dB ± 3

Spurious Response Rejection Ratio	70 dB
Adjacent Channel Selectivity	70 dB
Intermodulation Rejection Ratio	68 dB
Scan Time per Channel	200 ms
Speaker Jack output	1.8 V (8ohm load @ max vol)
Current Drain at:	
Max Audio Power	200 mA
Standby	40 mA

## Transmitter

RF Power:		
Hi Mode		5 W $\pm$ 0.5
Lo Mode		1 W $\pm$ 0.2
Carrier Frequency Tolerance		$\pm$ 10 PPM
Maximum Limiting		$\pm$ 5 KHz
Carrier Attack Time		80 ms
Audio Response	@300Hz	-12dB $\pm$ 3
	@2500Hz	+6 dB $\pm$ 3
Audio Distortion @ 2.5KHz dew.		3%
Hum and Noise Ratio		35 dB
Spurious/Harmonic Emissions		< 60 dB
Mic Sensitivity for 3kHz		10 mV $\pm$ 3
Conducted Spurious Emission		<0.25 $\mu$ W
Transient Frequency Behavior		
TX on		30 ms
TX off		5 ms
Current Drain		
Hi Power		1800 mA
Lo Power		700 mA
Charging Current		750 mA $\pm$ 50

## Appendix B: Channel List

### International VHF Marine Radio Channels & Frequencies

CH No.	XMIT Freq	RCV Freq	Single Freq	Use
01	156.050	160.650		Public Correspondence, Port Operations and Ship Movement
02	156.100	160.700		Public Correspondence, Port Operations and Ship Movement
03	156.150	160.750		Public Correspondence, Port Operations and Ship Movement
04	156.200	160.800		Public Correspondence, Port Operations and Ship Movement
05	156.250	160.850		Public Correspondence, Port Operations and Ship Movement
06	156.300	156.300	x	Intership <sup>1</sup>
07	156.350	160.950		Public Correspondence, Port Operations and Ship Movement
08	156.400	156.400	x	Intership
09	156.450	156.450	x	Intership, Port Operations and Ship Movement
10	156.500	156.500	x	Intership, Port Operations and Ship Movement <sup>2</sup>
11	156.550	156.550	x	Port Operations and Ship Movement
12	156.600	156.600	x	Port Operations and Ship Movement
13	156.650	156.650	x	Intership Safety, Port Operations and Ship Movement <sup>3</sup>
14	156.700	156.700	x	Port Operations and Ship Movement
15	156.750	156.750	x	Intership and On-board Communications at 1W only <sup>4</sup>
16	156.800	156.800	x	Distress, Safety and Calling
17	156.850	156.850	x	Intership and On-board Communications at 1W only <sup>4</sup>
18	156.900	161.500		Public Correspondence
19	156.950	161.550		Public Correspondence, Port Operations and Ship Movement
20	157.000	161.600		Public Correspondence, Port Operations and Ship Movement
21	157.050	161.650		Public Correspondence, Port Operations and Ship Movement
22	157.100	161.700		Public Correspondence, Port Operations and Ship Movement
23	157.150	161.750		Public Correspondence, Port Operations and Ship Movement

<b>CH No.</b>	<b>XMIT Freq</b>	<b>RCV Freq</b>	<b>Single Freq</b>	<b>Use</b>
24	157.200	161.800		Public Correspondence, Port Operations and Ship Movement
25	157.250	161.850		Public Correspondence, Port Operations and Ship Movement
26	157.300	161.900		Public Correspondence, Port Operations and Ship Movement
27	157.350	161.950		Public Correspondence, Port Operations and Ship Movement
28	157.400	162.000		Public Correspondence, Port Operations and Ship Movement
60	156.025	160.625		Public Correspondence, Port Operations and Ship Movement
61	156.075	160.675		Public Correspondence, Port Operations and Ship Movement
62	156.125	160.725		Public Correspondence, Port Operations and Ship Movement
63	156.175	160.775		Public Correspondence, Port Operations and Ship Movement
64	156.225	160.825		Public Correspondence, Port Operations and Ship Movement
65	156.275	160.875		Public Correspondence, Port Operations and Ship Movement
66	156.325	160.925		Public Correspondence, Port Operations and Ship Movement
67	156.375	156.375	x	Intership, Port Operations and Ship Movement
68	156.425	156.425	x	Port Operations and Ship Movement
69	156.475	156.475	x	Port Operations and Ship Movement
71	156.575	156.575	x	Port Operations and Ship Movement
72	156.625	156.625	x	Intership
73	156.675	156.675	x	Intership <sup>2</sup>
74	156.725	156.725	x	Port operations and Ship movement
75	156.775	156.775	x	See Note 5
76	156.825	156.825	x	See Note 5
77	156.875	156.875	x	Intership
78	156.925	161.525		Public correspondence, Port Operations and Ship Movement
79	156.975	161.575		Public correspondence, Port Operations and Ship Movement
80	157.025	161.625		Public correspondence, Port Operations and Ship Movement
81	157.075	161.675		Public correspondence, Port Operations and Ship Movement

<b>CH No.</b>	<b>XMIT Freq</b>	<b>RCV Freq</b>	<b>Single Freq</b>	<b>Use</b>
82	157.125	161.725	x	Public correspondence, Port Operations and Ship Movement
83	157.175	161.775	x	Public correspondence, Port Operations and Ship Movement
84	157.225	161.825	x	Public correspondence, Port Operations and Ship Movement
85	157.275	161.875	x	Public correspondence, Port Operations and Ship Movement
86	157.325	161.925	x	Public correspondence, Port Operations and Ship Movement
87	157.375	157.375	x	Port Operations and Ship Movement
88	157.425	157.425	x	Port Operations and Ship Movement

- Intership channels are for communications between ship stations. Intership communications should be restricted to Channels 6, 8, 72 and 77. If these are not available, the other channels marked for Intership may be used.
- Channels 10, 67 and 73 should be avoided within VHF range of coastal areas in Europe and Canada.
- Channel 70 is used exclusively for Digital Selective Calling (DSC) and is not available for regular voice communications.

### Notes:

1. Channel 06 may also be used for communications between ship stations and aircraft engaged in coordinated search and rescue operations. Ship stations should avoid harmful interference to such communications on channel 06 as well as to communications between aircraft stations, ice breakers and assisted ships during ice seasons.
2. Channels 10 or 73 (depending on location) are also used for the broadcast of Marine Safety Information by the Maritime and Coast Guard Agency in the UK only.
3. Channel 13 is designated for use on a worldwide basis as a navigation safety communication channel, primarily for intership navigation safety communications.
4. Channels 15 and 17 may also be used for on-board communications provided the effective radiated power does not exceed 1 Watt.
5. The use of Channels 75 and 76 should be restricted to navigation related communication only and all precautions should be taken to avoid harmful interference to channel 16. Transmit power is limited to 1 Watt.

## European Private Channels and Frequencies

Country	Channel Number	TX Freq	RX Freq	Channel Use
Belgium	31A	157.550	162.150	n/a
	96D	162.425	162.425	n/a
Denmark	L1	155.500	155.500	Pleasure Boat
	L2	155.525	155.525	Pleasure Boat
Denmark, Finland, Norway & Sweden	F1	155.625	155.625	Fishing Boat
	F2	155.775	155.775	Fishing Boat
	F3	155.825	155.825	Fishing Boat
Finland, Norway & Sweden	L1	155.500	155.500	Pleasure Boat
	L2	155.525	155.525	Pleasure Boat
	L3	155.650	155.650	Pleasure Boat
Netherlands	31A	157.550	162.150	n/a
	37C	157.850	157.850	n/a
UK	M1	157.850	157.850	Pleasure Boat
	M2	161.425	161.425	Pleasure Boat

**Note:** A license may be required to operate the radio on the private channels. It is your responsibility to obtain the proper license to operate the radio on these frequencies.

## U.S. VHF Marine Radio Channels and Frequencies

<b>CH. No</b>	<b>XMIT Freq</b>	<b>RCV Freq</b>	<b>Single Freq</b>	<b>Use</b>
01A	156.050	156.050	x	Port Operations and Commercial, VTS. Available only in New Orleans / Lower Mississippi area. <sup>1</sup>
03A	156.150	156.150	x	Port Operations
05A	156.250	156.250	x	Port Operations or VTS in the Houston, New Orleans and Seattle areas.
06	156.300	156.300	x	Intership Safety
07A	156.350	156.350	x	Commercial
08	156.400	156.400	x	Commercial (Intership only)
09	156.450	156.450	x	Boater Calling. Commercial and Non-Commercial.
10	156.500	156.500	x	Commercial
11	156.550	156.550	x	Commercial. VTS in selected areas.
12	156.600	156.600	x	Port Operations. VTS in selected areas.
13	156.650	156.650	x	Intership Navigation Safety (Bridge-to-bridge). Ships >20meters in length maintain a listening watch on this channel in US waters. <sup>2</sup>
14	156.700	156.700	x	Port Operations. VTS in selected areas.
15	-	156.750	x	Environmental (Receive only). Used by Class 'C' EPIRBs.
16	156.800	156.800	x	International Distress, Safety and Calling. Ships required to carry radio, USCG, and most coast stations maintain a listening watch on this channel. <sup>3</sup>
17	156.850	156.850	x	State Control
18A	156.900	156.900	x	Commercial
19A	156.950	156.950	x	Commercial
20	157.000	161.600		Port Operations (duplex)
20A	157.000	157.000	x	Port Operations
21A	157.050	157.050	x	U.S. Coast Guard only
22A	157.100	157.100	x	Coast Guard Liaison and Maritime Safety Information Broadcasts. Broadcasts announced on channel 16.

<b>CH. No</b>	<b>XMIT Freq</b>	<b>RCV Freq</b>	<b>Single Freq</b>	<b>Use</b>
23A	157.150	157.150	x	U.S. Coast Guard only
24	157.200	161.800		Public Correspondence (Marine Operator)
25	157.250	161.850		Public Correspondence (Marine Operator)
26	157.300	161.900		Public Correspondence (Marine Operator)
27	157.350	161.950		Public Correspondence (Marine Operator)
28	157.400	162.000		Public Correspondence (Marine Operator)
61A	156.075	156.075	x	U.S. Coast Guard only
63A	156.175	156.175	x	Port Operations and Commercial, VTS. Available only in New Orleans / Lower Mississippi area.
64A	156.225	156.225	x	U.S. Coast Guard only
65A	156.275	156.275	x	Port Operations
66A	156.325	156.325	x	Port Operations
67	156.375	156.375	x	Commercial. Used for Bridge-to-bridge communications in lower Mississippi River. Intership only.
68	156.425	156.425	x	Non-Commercial
69	156.475	156.475	x	Non-Commercial
71	156.575	156.575	x	Non-Commercial
72	156.625	156.625	x	Non-Commercial (Intership only)
73	156.675	156.675	x	Port Operations
74	156.725	156.725	x	Port Operations
77	156.875	156.875	x	Port Operations (Intership only)
78A	156.925	156.925	x	Non-Commercial
79A	156.975	156.975	x	Commercial. Non-Commercial in Great Lakes only.
80A	157.025	157.025	x	Commercial. Non-Commercial in Great Lakes only
81A	157.075	157.075	x	U.S. Government only – Environmental protection operations.
82A	157.125	157.125	x	U.S. Government only
83A	157.175	157.175	x	U.S. Coast Guard only

<b>CH. No</b>	<b>XMIT Freq</b>	<b>RCV Freq</b>	<b>Single Freq</b>	<b>Use</b>
84	157.225	161.825		Public Correspondence (Marine Operator)
85	157.275	161.875		Public Correspondence (Marine Operator)
86	157.325	161.925		Public Correspondence (Marine Operator)
87	157.375	161.975		Public Correspondence Marine Operator)
88	157.425	162.025		Public Correspondence only near Canadian border
88A	157.425	157.425	x	Commercial, Intership only

- Boaters should normally use channels listed as Non-Commercial.
- Channels 13 and 67 are initially set to 1 watt output power only. You can temporarily override this restriction to transmit at high power if necessary.
- Channel 70 is used exclusively for Digital Selective Calling (DSC) and is not available for regular voice communications.
- Channels 75 and 76 are reserved as guard bands for Channel 16 and are not available for regular voice communications.

### Notes:

1. The letter "A" following a channel number indicates simplex use of the ship station transmit side of an international duplex channel. Operations are different from that of international operations on that channel.
2. Channel 13 should be used to contact a ship when there is danger of collision. All ships of length 20 meters or greater are required to guard VHF channel 13, in addition to VHF channel 16, when operating within U.S. territorial waters.
3. Channel 16 is used for calling other stations or for distress alerting.

## Canadian VHF Marine Radio Channels and Frequencies

<b>CH No.</b>	<b>XMIT Freq</b>	<b>RCV Freq</b>	<b>Area of Operation</b>	<b>Use</b>
01	156.050	160.650	PC	Public Correspondence
02	156.100	160.700	PC	Public Correspondence
03	156.150	160.750	PC	Public Correspondence
04A	156.200	156.200	PC	Intership, Ship/Shore and Safety: Canadian Coast Guard search and rescue <sup>1</sup>
04A	156.200	156.200	EC	Intership, Ship/Shore and Commercial: Commercial fishing only
05A	156.250	156.250		Ship Movement
06	156.300	156.300	All areas	Intership, Commercial, Non-commercial and Safety: May be used for search and rescue communications between ships and aircraft.
07A	156.350	156.350	All areas	Intership, Ship/Shore, Commercial
08	156.400	156.400	WC, EC	Intership, Commercial and Safety: Also assigned for operations in the Lake Winnipeg area.
09	156.450	156.450	AC	Intership, Ship/Shore, Commercial, Non-commercial and Ship Movement: May be used to communicate with aircraft and helicopters in predominantly maritime support operations.
10	156.500	156.500	AC, GL	Intership, Ship/Shore, Commercial, Non-commercial, Safety and Ship Movement: May also be used for communications with aircraft engaged in coordinated search and rescue and antipollution operations.
11	156.550	156.550	PC, AC, GL	Intership, Ship/Shore, Commercial, Non-commercial and Ship Movement: Also used for pilotage purposes.
12	156.600	156.600	WC, AC, GL	Intership, Ship/Shore, Commercial, Non-commercial and Ship Movement: Port operations and pilot information and messages.
13	156.650	156.650	All areas	Intership, Commercial, Non-commercial and Ship Movement: Exclusively for bridge-to-bridge navigational traffic.
14	156.700	156.700	AC, GL	Intership, Ship/Shore, Commercial, Non-commercial and Ship Movement: Port operations and pilot information and messages.

<b>CH No.</b>	<b>XMIT Freq</b>	<b>RCV Freq</b>	<b>Area of Operation</b>	<b>Use</b>
15	156.750	156.750	All areas	Intership, Ship/Shore, Commercial, Non-commercial and Ship Movement: All operations limited to 1-watt maximum power. May also be used for on-board communications.
16	156.800	156.800	All areas	International Distress, Safety and Calling <sup>2</sup>
17	156.850	156.850	All areas	Intership, Ship/Shore, Commercial, Non-commercial and Ship Movement: All operations limited to 1-watt maximum power. May also be used for on-board communications.
18A	156.900	156.900	All areas	Intership, Ship/Shore and Commercial: Towing on the Pacific Coast.
19A	156.950	156.950	All areas except PC	Intership and Ship/Shore: Canadian Coast Guard only.
19A	156.950	156.950	PC	Intership and Ship/Shore: Various Government departments.
20	157.000	161.600	All areas	Ship/Shore, Safety and Ship Movement: Port operations only with 1-watt maximum power.
21A	157.050	157.050	All areas	Intership and Ship/Shore: Canadian Coast Guard only.
21B	-	161.650	All areas	Safety: Continuous Marine Broadcast (CMB) service. <sup>3</sup>
22A	157.100	157.100	All areas	Intership, Ship/Shore, Commercial and Non-commercial: For communications between Canadian Coast Guard and non-Canadian Coast Guard stations only.
23	157.150	161.750	PC	Ship/Shore and Public Correspondence: Also in the inland waters of British Columbia and the Yukon.
24	157.200	161.800	All areas	Ship/Shore and Public Correspondence
25	157.250	161.850	PC	Ship/Shore and Public Correspondence: Also assigned for operations in the Lake Winnipeg area.
25B	-	161.850	AC	Safety: Continuous Marine Broadcast (CMB) service.
26	157.300	161.900	All areas	Ship/Shore, Safety and Public Correspondence
27	157.350	161.950	AC, GL, PC	Ship/Shore and Public Correspondence
28	157.400	162.000	PC	Ship/Shore, Safety and Public Correspondence
28B	-	162.000	AC	Safety: Continuous Marine Broadcast (CMB) service.

<b>CH No.</b>	<b>XMIT Freq</b>	<b>RCV Freq</b>	<b>Area of Operation</b>	<b>Use</b>
60	156.025	160.625	PC	Ship/Shore and Public Correspondence
61A	156.075	156.075	PC	Intership and Ship/Shore: Canadian Coast Guard only.
61A	156.075	156.075	EC	Intership, Ship/Shore and Commercial: Commercial fishing only.
62A	156.125	156.125	PC	Intership and Ship/Shore: Canadian Coast Guard only.
62A	156.125	156.125	EC	Intership, Ship/Shore and Commercial: Commercial fishing only.
64	156.225	160.825	PC	Ship/Shore and Public Correspondence
64A	156.225	156.225	EC	Intership, Ship/Shore and Commercial: Commercial fishing only.
65A	156.275	156.275		Intership, Ship/Shore, Commercial, Non-commercial, Safety: Search & rescue and antipollution operations on the Great Lakes. Towing on the Pacific Coast. Port operations only in the St. Lawrence River areas with 1W maximum power. Pleasure craft in the inland waters of Alberta, Saskatchewan and Manitoba (excluding Lake Winnipeg and the Red River).
66A	156.325	156.325		Intership, Ship/Shore, Commercial, Non-commercial, Safety and Ship Movement: Port operations only in the St. Lawrence River/Great Lakes Areas with 1-watt maximum power.
67	156.375	156.375	EC	Intership, Ship/Shore and Commercial: Commercial fishing only.
67	156.375	156.375	All areas except EC	Intership, Ship/Shore, Commercial, Non-commercial, Safety: May also be used for communications with aircraft engaged in coordinated search and rescue and antipollution operations.
68	156.425	156.425	All areas	Intership, Ship/Shore and Non-commercial: For marinas and yacht clubs.
69	156.475	156.475	All areas except EC	Intership, Ship/Shore, Commercial and Non-commercial
69	156.475	156.475	EC	Intership, Ship/Shore and Commercial: Commercial fishing only
71	156.575	156.575	PC	Intership, Ship/Shore, Commercial, Non-commercial, Safety and Ship Movement

<b>CH No.</b>	<b>XMIT Freq</b>	<b>RCV Freq</b>	<b>Area of Operation</b>	<b>Use</b>
71	156.575	156.575		Intership, Ship/Shore and Non-commercial: For marinas and yacht clubs on the East Coast and on Lake Winnipeg.
72	156.625	156.625	EC, PC	Intership, Commercial and Non-commercial: May be used to communicate with aircraft and helicopters in predominantly maritime support operations.
73	156.675	156.675	EC	Intership, Ship/Shore and Commercial: Commercial fishing only
73	156.675	156.675	All areas except EC	Intership, Ship/Shore, Commercial, Non-commercial, Safety: May also be used for communications with aircraft engaged in coordinated search and rescue and antipollution operations.
74	156.725	156.725	EC, PC	Intership, Ship/Shore, Commercial, Non-commercial and Ship Movement
77	156.875	156.875		Intership, Ship/Shore, Safety and Ship Movement: Pilotage on Pacific Coast. Port operations only in the St. Lawrence River/Great Lakes areas with 1W maximum power.
78A	156.925	156.925	EC, PC	Intership, Ship/Shore and Commercial
79A	156.975	156.975	EC, PC	Intership, Ship/Shore and Commercial
80A	157.025	157.025	EC, PC	Intership, Ship/Shore and Commercial
81A	157.075	157.075		Intership and Ship/Shore: Canadian Coast Guard use only in the St. Lawrence River/Great Lakes areas.
81A	157.075	157.075	PC	Intership, Ship/Shore and Safety: Canadian Coast Guard antipollution.
82A	157.125	157.125	PC	Intership, Ship/Shore and Safety: Canadian Coast Guard use only.
82A	157.125	157.125		Intership and Ship/Shore: Canadian Coast Guard use only in the St. Lawrence River/Great Lakes areas.
83	157.175	161.775	PC	Ship/Shore and Safety: Canadian Coast Guard use only.
83A	157.175	157.175	EC	Intership and Ship/Shore: Canadian Coast Guard and other Government agencies.
83B	-	161.775	AC, GL	Safety: Continuous Marine Broadcast (CMB) Service.
84	157.225	161.825	PC	Ship/Shore and Public Correspondence

<b>CH No.</b>	<b>XMIT Freq</b>	<b>RCV Freq</b>	<b>Area of Operation</b>	<b>Use</b>
85	157.275	161.875	AC, GL, NL	Ship/Shore and Public Correspondence
86	157.325	161.925	PC	Ship/Shore and Public Correspondence
87	157.375	161.975	AC, GL, NL	Ship/Shore and Public Correspondence
88	157.425	162.025	AC, GL, NL	Ship/Shore and Public Correspondence

### Area of Operation

AC: Atlantic Coast, Gulf and St. Lawrence River up to and including Montreal

EC (East Coast): includes NL, AC, GL and Eastern Arctic areas

GL: Great Lakes (including St. Lawrence above Montreal)

NL: Newfoundland and Labrador

PC: Pacific Coast

WC (West Coast): Pacific Coast, Western Arctic and Athabasca-Mackenzie Watershed areas

All areas: includes East and West Coast areas

### Notes:

1. The letter "A" following a channel number indicates simplex use of the ship station transmit side of an international duplex channel. Operations are different from that of international operations on that channel.
2. Channel 16 is used for calling other stations or for distress alerting.
3. The letter "B" following a channel number indicates simplex use of the coast station transmit side of an international duplex channel. That is, the channel is Receive Only.
4. Channel 70 is used exclusively for Digital Selective Calling (DSC) and is not available for regular voice communications.
5. Channels 75 and 76 are reserved as guard bands for Channel 16 and are not available for regular voice communications.

## **WX Channels (North America only)**

<b>Weather Channel</b>	<b>Frequency in MHz</b>
WX 1	162.550
WX 2	162.400
WX 3	162.475
WX 4	162.425
WX 5	162.450
WX 6	162.500
WX 7	162.525
WX 8	161.650
WX 9	161.775
WX 10	163.275



## Appendix C: Glossary

<b>Term</b>	<b>Meaning</b>
All Scan	A feature that scans all channels.
ATIS	Automatic Transmission Identification System. Used for inland waterways in some European countries.
Canadian Channels	Channel designator as defined by Industry Canada.
CH	Channel selection key
Dual Watch	A feature that monitors the Priority Channel 16 while working on another channel.
Duplex	Transmit and receive on different frequencies
FCC	Federal Communications Commission (US)
International Channels	Channel designator as defined by the ITU
ITU	International Telecommunications Union
LCD	Liquid Crystal Display
NOAA	National Oceanographic and Atmospheric Administration (USA)
Priority Channel	Channel 16
Priority Mode	Initiated by pressing the 16/PLUS key, this mode instantly places the radio at Channel 16 at high power.
Priority Scan (PSCAN)	A feature that alternates monitoring the Priority Channel 16 with each of the regular channels
PTT switch	Microphone Push-To-Talk switch
RF	Radio Frequency
RX	Receive
Saved Scan	Scans only user-selected memory channels
Simplex	Transmit and receive on the same frequency
Squelch	A circuit that sets the threshold for cutting off the receiver when the signal is too weak for reception of anything but noise.
TX	Transmit
Tri Watch	A function that monitors the Priority Channel and (previously programmed) Favourite Channel while working on another channel.

---

<b>Term</b>	<b>Meaning</b>
US Channels	Channel designations as defined by the FCC.
VOL	Volume key
VHF	Very High Frequency (30MHz to 300MHz)
Weather (WX) Channels	Channels for routine and emergency weather information broadcast by NOAA (USA).
Working Channel	The currently-selected (non-priority, non-WX) channel.

---

# Index

## Symbols

- "\*" key 23
- "A" indicator 25
- "B" indicator 25
- "C" indicator 25
- "I" indicator 25
- "P" indicator 25
- "U" indicator 25

## Numerics

- 16/PLUS key 23

## A

- Adding channels to memory 38
- ALERT indicator 26
- All Scan function 35
- Antenna 13
- ATIS 12
  - Indicator 26
  - Programming 42

## B

- Backlight 23, 34
- BAND function 30
- Battery 14
  - Charging 17
  - Level indicator 25
  - Tray 15
  - Type switch 15
- Belt Clip 14

## C

- Canadian channels 58
- CH indicator 25
- Channel List
  - Canadian frequencies 58
  - International frequencies 51
  - US frequencies 55
  - WX frequencies 63
- Channel Set selection 23

- Channel Sets 30
- Channel setting 29
- Channel UP/DOWN 23
- Charging batteries 17
- Conventions 7
- Customer Support 47

## D

- Delete channels from memory 38
- DUAL indicator 26
- Dual Watch 23, 39

## E

- Equipment supplied 13

## F

- Factory reset 46
- Features 11
- Frequency Band 30
- Frequency settings
  - Canadian channels 58
  - International channels 51
  - US channels 55
  - WX channels 63

## G

- Glossary 65

## H

- Help from Raymarine 47
- HI/LO / USER key 23
- HI/LO indicator 26
- HI/LOW power selection 23, 28

## I

- Installation 13
- International channels 51

## K

- Keylock 23, 34
- Keylock indicator 26

## L

- LCD display 24
- Licensing requirements 12

**M**

Memory 38  
Monitor modes 39, 40

**P**

Power 22  
Power ON/OFF 27  
Power selection 28  
Priority Channel 31  
Priority Mode 25, 31  
Priority Scan function 37  
PSCAN indicator 25  
PTT 22, 33  
Push-To-Talk key 33

**R**

Raymarine  
    Website 47  
Recharging batteries 17  
Reset 46  
RX indicator 24

**S**

Save channels to memory 38  
SAVED indicator 25  
Saved Scan function 36  
Scan function 35  
SCAN indicator 25  
SCAN/SAVE key 23  
Signal strength 26  
Squelch 22, 28

**T**

Transmitting 33  
TRI indicator 26  
Tri Watch 23, 40  
TX 33  
TX indicator 24

**U**

US channels 55  
USER Channel Mode 23, 41  
USER indicator 24

**V**

Volume 27

**W**

Warning 8  
Warranty 7  
Weather Alert 30  
Weather Channels 29  
Website 47  
Wrist Strap 14  
WX 29  
    channels 63  
    indicator 26